

Heinemann®

Circuit Breakers

EATON

Series CD-CE-CF

- Compact E-Frame circuit breakers
- Single and multiple pole
- Rating 0.01 to 100A

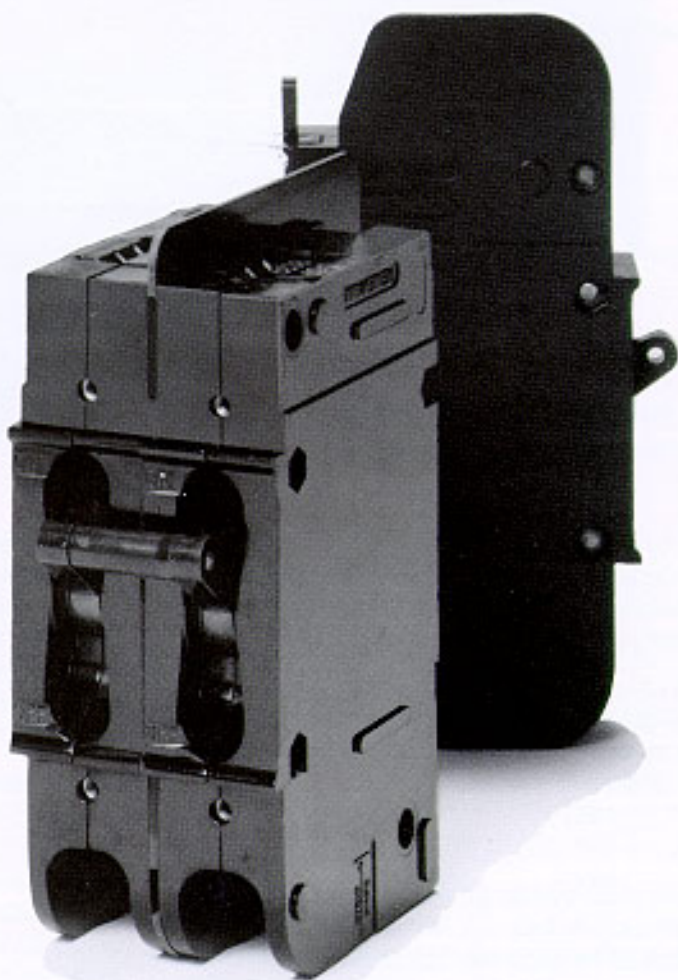
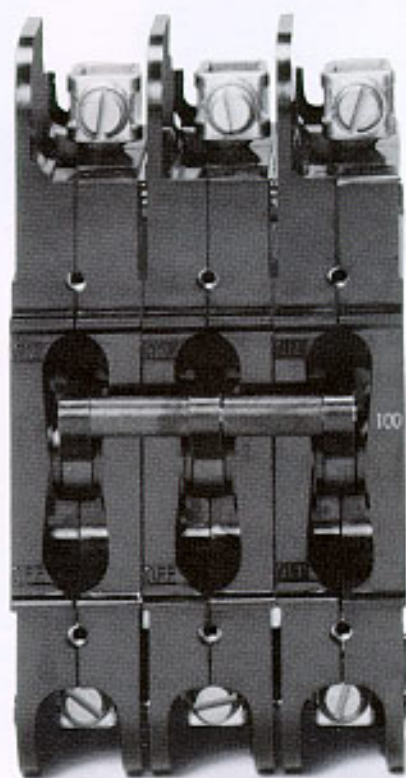

Bulletin CD

Compact, economical E-Frame circuit breakers in single and multiple models...

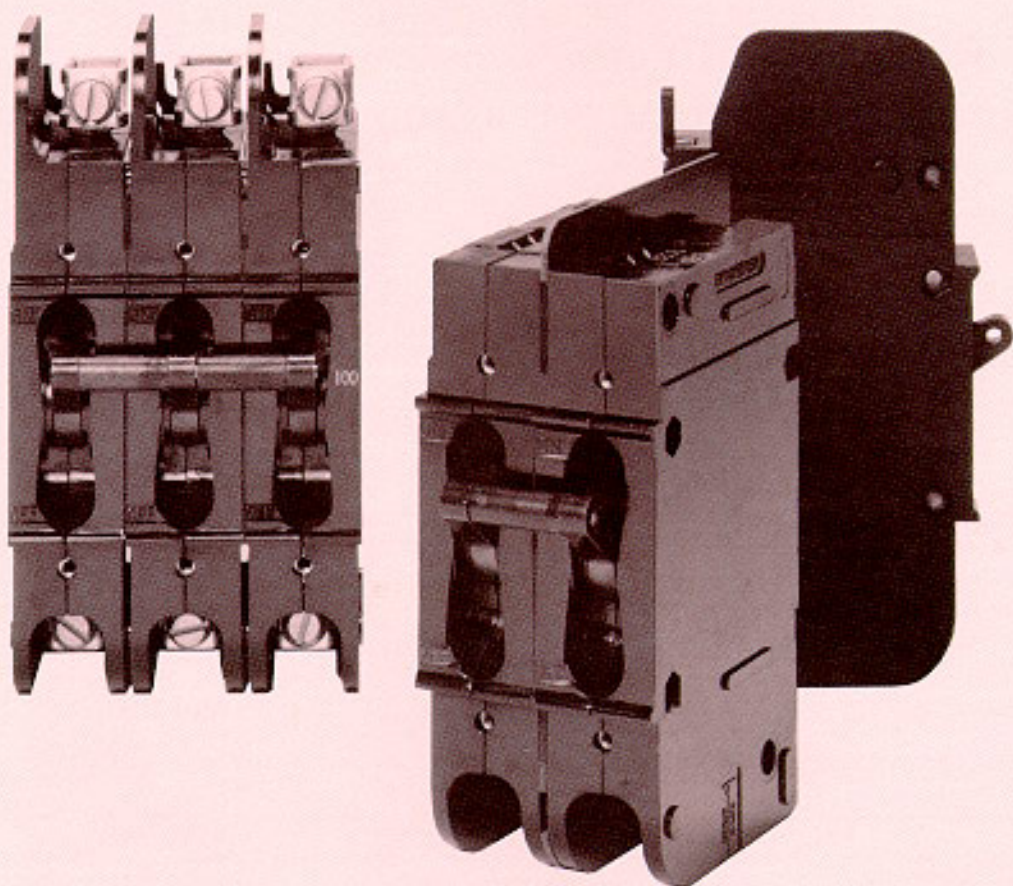

The Heinemann® E-Frame circuit breaker offers several important advantages to electrical contractors, panel builders and original-equipment manufacturers. It is priced considerably lower than competitive E-Frame breakers, and is substantially more compact.

In addition, it offers the many special advantages of hydraulic-magnetic actuation for which all Heinemann breakers are known. Single-pole and multipole models are stocked in a wide range of standard ratings for fast, off-the-shelf delivery.

For a wide range of applications

Heinemann E-Frame circuit breakers are among the most versatile and useful 100A models available today — a fact evidenced by the broad industrial acceptance so readily achieved by this comparatively new line of circuit breakers. They are equally at home in panelboards as well as data processing equipment, office equipment and environmental systems. An exceptional choice of current ratings, voltages, and time delays is provided (see pages 3 and 6).

Original equipment. Particularly valuable in 3-phase applications, Heinemann E-Frame breakers are also used extensively as equipment built-ins. Multipole models of up to 6 poles are available with individual or common-trip operation; special-function internal circuits may be varied from pole to pole. Non-standard integral or fractional current ratings as well as non-standard time delays (including high-inrush) can be supplied to user specification on a special-order basis.

UL/CSA-recognized at 480V 50/60 Hz. Heinemann's compact Series CF breaker, normally limited to a maximum voltage of 240V, is now recognized by both Underwriters' Laboratories and the Canadian Standards Association at 480V and 600V at 50/60 Hz as a Component — Manual Motor Controller. Refer to UL File E-11939. This approval permits the CF to be used in a multitude of electrical heating, air conditioning and other high-voltage equipment applications where overload protection, rather than fault interruption, is the design criterion.

General Specifications

Model

CD1-G3 for 120/240V 50/60 Hz (see note 9)

Terminal arrangement – front connected

LINE

10/32 screw for bus connection to 100 amp and short mounting foot

LOAD

Washerhead screw to 34 amp

Pressure connector 34.1-100 amp for use with stripped wire

Mounting arrangement

Back mounted with short mounting foot and slotted hole

Model

CF1-G3 for 120/240V 50/60 Hz (see note 9)

Terminal arrangement – front connected

LINE

Pressure connector for use with stripped wire

LOAD

Same as LINE

Mounting arrangement

Back mounted with slotted mounting foot and slotted hole

Model

CE1-G3 for 120/240V 50/60 Hz (see note 9)

Terminal arrangement – front connected

LINE

Pressure connector for use with stripped wire

LOAD

Same as LINE

Mounting arrangement

Back mounted with short mounting foot and slotted hole

Model

CD2-A3 for 240V 50/60 Hz (see note 9)

Terminal arrangement – back connected

LINE

Threaded studs

LOAD

Same as LINE

Mounting arrangement

Front mounted with 6-32 threaded inserts

Ratings available:

Number of Poles	Current Rating*	UL Approval**	Maximum Voltage	Interrupting Capacity	Maximum Series Fuse	See Note
1	1-100	Listed	120 VAC 50/60 Hz	5,000	None	1, 8
	1-100	Listed	120/240 VAC 50/60 Hz	5,000	None	1, 8
	1-100	Listed	240 VAC 50/60 Hz	7,500	None	1
	1-64	Recognized	277/480 VAC 50/60 Hz	5,000	4X Rating	2, 4, 7
	65-100	Recognized	277/480 VAC 50/60 Hz	10,000	225	2, 7
2-6	1-64	Recognized	480 VAC 50/60 Hz	5,000	4X Rating	2, 4, 7
	65-100	Recognized	480 VAC 50/60 Hz	10,000	225	2, 7
	9-30	Recognized	600 VAC 50/60 Hz	5,000	4X Rating	2, 4, 7
	32-77	Recognized	600 VAC 50/60 Hz	10,000	225	2, 7
	2-6	1-100	Recognized	240 VAC 400 Hz	2,000	None
1-2	110	Listed	65 Vdc	25,000	None	1
1-6	110	Listed	125 Vdc	5,000	None	1
1	100	Recognized	160 Vdc	5,000	None	3

NOTES:

- UL-489 Listed.
- UL-508 Recognized with K5 UL approved back-up fuse.
- UL-1077 Recognized.
- Minimum fuse rating 15 amps.
- Ratings available as low as 0.01 amp without UL approval.

- Canadian Standards Association approved as listed in File LR-3962 and LR-9646.
- Devices are rated 3 phase Y or single phase (2 poles breaking).
- 10,000 amp Interrupting Capacity available with a factory assigned part number.
- CE, CF units available front connected only. CD units available as front or back connected.

How to order standard Series CD, CE, CF circuit breakers

Note: Standard catalog number must have 18 digits including dashes. See How to Order non-standard when all poles of a multipole unit are not identical.

Step 1

CD3-

Series prefix (CD, CE, CF) and number of poles (1-6) include a dash as shown.

CD3-

Step 1

-A3-

Step 2a & b

DU

Step 3

0015

Step 4

-02

Step 5

A

Step 6

Step 2a Table A

-A3-

Code	Frequency	Terminal Location
A	50/60 Hz	Back
B	DC	Back
G	50/60 HZ	Front
H	DC	Front

Add a dash before the code letter.

Step 2b Table B

-A3-

Code	Inrush Code			VDE App.	Internal Circuit Construction	See Notes
	N/A	Std.	25x			
0				No	Switch only (no coil)	
2		9		Yes	*Series trip with SPDT aux. switch	1,2,3
3		8		Yes	Series trip	1

*On multipole units one aux. switch is supplied. It is located in the left pole when viewed from the front of the breaker. See page 5 for non-standard part number when additional switches or pole locations are required. See Note 3.

Notes:

1. Maximum current rating at 125 Vdc and 65 Vdc is 110 amps.
2. Auxiliary switch is rated for 10.1 amps, 125/250 VAC. Low level switches rated at 0.1 amps, 125 VAC are available under factory assigned part number.
3. Auxiliary switch VDE approved for use in circuits above 42 volts. Not approved for SELV circuits.

Step 3 Table C

DU

Add a dash after single digit UL codes.

Code	UL		Maximum	Voltage
	Standard	Type Approval		
U-	UL-489	Branch Circuit - General Purpose	240AC	125DC
DU	UL-489	Branch Circuit - Special Purpose	240AC	125DC
AB	UL-508	Manual Motor Controller	480	—
AE	UL-508	Manual Motor Controller	600AC	—

Breakers will be marked with the maximum UL approved voltage.

Step 4 Table D

0015

Standard Current Ratings

Current		Current	
Code	Ampere	Code	Ampere
0001	1.00	0025	25.00
02R5	2.50	0030	30.00
0005	5.00	0050	50.00
07R5	7.50	0060	60.00
0010	10.00	0070	70.00
0015	15.00	0100	100.00
0020	20.00		

For other current ratings consult factory.

Step 5 Table E

-02

Time Delay Curves

Code	Inrush Level		Time Delay
	Std.	25x	
-01	x		Long
-02	x		Medium
-03	x		Short
100		x	Motor Start
-10		x	Long
-20		x	Medium
-30		x	Short

See time delay curves on pages 6 and 7 for required delay.

Step 6 Table F

A

Code	Voltage Rating
A	0-250 VAC
B	251-600 VAC
C	0-125 Vdc
D	126-160 Vdc
H	VDE 125 Vdc or 380 VAC, 50/60 Hz

VDE 0660 approval applies to DC and 50/60 Hz constructions listed under VDE column in Table B.

How to order non-standard* CD, CE, CF Series circuit breakers

*Non-standard part numbers may require a factory assigned part number.

Step 1

CD3

Series prefix (CD, CE, CF) and number of poles (1-6).

CD3

Step 1

-A2A3A3-

Step 2a & b

DU

Step 3

-40

Step 4

-02

Step 5

Step 2a Table A

-A2A3A3-

Voltage, frequency and internal circuit for first pole on left as viewed from front of panel, or for all poles if identical, from Tables A and B.

Code	Frequency	Terminal Location
A	50/60 Hz	Back
B	DC	Back
C	400 Hz	Back
G	50/60 HZ	Front
H	DC	Front
J	400 Hz	Front

Step 3 Table C

DU

UL Codes

Code	Standard	Type Approval	Maximum	Voltage
U	UL-489	Branch Circuit – General Purpose	240AC	125DC
DU	UL-489	Branch Circuit – Special Purpose	240AC	125DC
A	UL-508	Manual Motor Controller – Appliance Controller	240AC	—
L	UL-508	Manual Motor Controller	277	—
AB	UL-508	Manual Motor Controller	480	—
AE	UL-508	Manual Motor Controller	600AC	—
DC	UL-508	Manual Motor Controller	—	125DC
D	UL-1077	Supplementary Protector	240AC	160DC

Breakers will be marked with the maximum UL approved voltage.

Step 4 Table D

-40

Standard Current Ratings

Current Code	Current Ampere	Current Code	Current Ampere	Current Code	Current Ampere
0001	1.00	0015	15.00	0050	50.00
02R5	2.50	0020	20.00	0060	60.00
0005	5.00	0025	25.00	0070	70.00
07R5	7.50	0030	30.00	0100	100.00
0010	10.00	Other non-listed ratings are available. Consult factory for availability and lead times.			

Step 2b Table B

-A2A3A3-

Repeat Step 2 for second and third poles and subsequent poles if different from first.

Circuit Codes

N/A	Inrush		VDE App.	Internal Circuit Construction	See Notes
	Std.	25x			
0			No	Switch (no overload coil)	—
	2	9	Yes	Series trip with standard enclosed SPDT aux. switch	1, 5, 6, 7
	3	8	Yes	Series trip	1, 7
	5		—	Shunt/tap (consult factory for VDE)	2, 3
	6		No	Relay-trip	3
12			No	Switch with standard enclosed SPDT aux. switch	5
	15–	25	No	Du-Con with Shunt/Tap voltage coil	4
	16	26	No	Du-Con with relay-trip voltage coil	4

Notes:

- Maximum current rating at 125 Vdc and 65 Vdc is 110 amps.
- Voltage rated shunt coils trip on line voltage.
- Contact rating for shunt and relay is 100 amps.
- Du-Con voltage coils require 30 VA to operate and are rated for intermittent duty. Specify Du-Con voltage rating after part number. A factory assigned part number is required.
- Auxiliary switch is rated for 10.1 amps, 125/250 VAC. Low level switches are rated at 0.1 amps, 125 VAC are available under factory assigned part number.
- Auxiliary switch VDE approved for use in circuits above 42 volts. Not approved for SELV circuits.
- VDE breakers require a factory assigned part number.

Step 5 Table E

-02

Time Delay Curves

Code	Inrush Level Std.	25x	Time Delay
-0P	x		None
-01	x		Long
-02	x		Medium
-03	x		Short
100		x	Motor Start
-10		x	Long
-20		x	Medium
-30		x	Short

See time delay curves on pages 6 and 7 for required delay.

Time-delay curves and applications

The curves shown indicate the magnitude and duration of overloads which will be tolerated before tripping occurs. By selecting the proper curve, breaker response can be closely matched to the safe operating limits of the equipment or circuitry.

Curve 1 allows the largest and most prolonged overload, needed to prevent nuisance tripping on motor circuits.

Curve 2 is a medium delay and accommodates mixed loads consisting of lights, motors and resistive heating where the breaker is rated to the wiring instead of to any specific load.

Curve 3 permits a very brief time delay period before tripping and is used for protection of transformers and electronic circuits.

Curves 10, 20 and 30

High-inrush — Time delays similar to Curves 1, 2 and 3 with high-inrush surge capabilities

Curve 100

High-inrush — For ferro-resonant power supplies, distribution transformers, data processing equipment, etc., which may draw starting surges as high as 3000% normal load. To accommodate brief surges of this magnitude for approximately a half cycle of line current, or 8.3 millisecond (long enough to get the equipment on line without tripping), high-inrush models are available.

Non-time-delay breakers have no deliberately imposed delay and will trip instantaneously at any load above 120% of rated current

Ambient effect on time delay

Breakers will hold 100% of rated current regardless of ambient temperature.

Time delay will decrease as ambient temperature is raised and increase as ambient is lowered.

Tripping Specifications

All time-delay curves shown are based on the fact that circuit breakers are not preloaded. (Breakers do not carry current prior to application of overload for calibration testing.) Curves are plotted at an ambient temperature of 77°F (25°C), with breakers in the standard wall-mount position.

All circuit breakers shall hold 100% rated load continuously. Breakers for 400 Hz operation may trip between 101% and 150% of rated load; must trip at 150% and above.

Other time-delay circuit breakers may trip between 101% and 125% of rated load; must trip at 125% and above, as shown on the time-delay curve selected.

Non-time-delay circuit breakers may trip instantaneously between 101% and 120% of rated load; must trip instantaneously at 120% and above. Non-time-delay 400 Hz breakers may trip instantaneously between 101% and 150% of rated load; must trip instantaneously at 150% and above.

50/60 Hz Curves

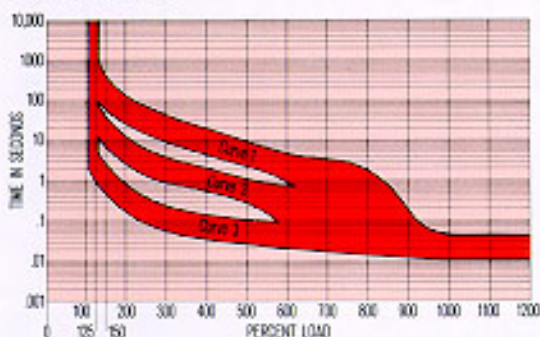

Percent of rated current vs. trip delay at 25° C

%	Curve#	100%	125%	200%	400%	600%	800%	1000%
Delay Max (sec)	1	no trip	880	110	18	4	1.6	0.045
Delay Min (sec)	1	no trip	100	20	4	0.9	0.013	0.010
Delay Max (sec)	2	no trip	90	10.5	1.84	0.64	0.190	0.045
Delay Min (sec)	2	no trip	13	2.1	0.46	0.03	0.013	0.010
Delay Max (sec)	3	no trip	6.4	0.60	0.130	0.075	0.052	0.040
Delay Min (sec)	3	no trip	0.80	0.15	0.032	0.019	0.013	0.010

400 Hz Curves

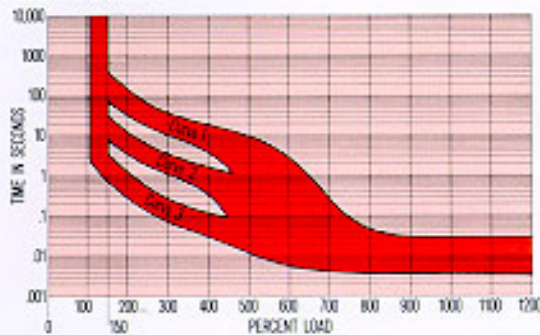

Percent of rated current vs. trip delay at 25° C

%	Curve#	100%	150%	200%	400%	600%	800%	1000%
Delay Max (sec)	1	no trip	400	150	17	2.7	0.050	0.028
Delay Min (sec)	1	no trip	95	35	4.3	0.03	0.008	0.0038
Delay Max (sec)	2	no trip	45	13	1.8	0.40	0.045	0.028
Delay Min (sec)	2	no trip	12	3.8	0.35	0.02	0.008	0.0038
Delay Max (sec)	3	no trip	4.5	0.90	0.13	0.04	0.030	0.028
Delay Min (sec)	3	no trip	0.8	0.023	0.03	0.0065	0.004	0.0038

DC Curves

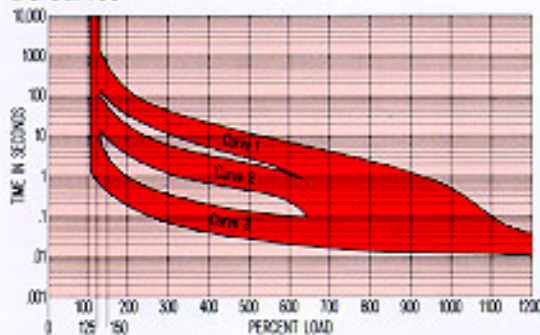

Percent of rated current vs. trip delay at 25° C

%	Curve#	100%	125%	200%	400%	600%	800%	1000%
Delay Max (sec)	1	no trip	1000	100	16	5.2	1.7	0.35
Delay Min (sec)	1	no trip	120	22	4	1.1	0.01	0.008
Delay Max (sec)	2	no trip	90	13	2.4	0.80	0.29	0.055
Delay Min (sec)	2	no trip	12	2.5	0.50	0.19	0.01	0.008
Delay Max (sec)	3	no trip	3	0.65	0.15	0.075	0.047	0.038
Delay Min (sec)	3	no trip	0.44	0.13	0.030	0.015	0.010	0.008

Time-delay curves and applications (continued)

60 Hz High-inrush Curve 10

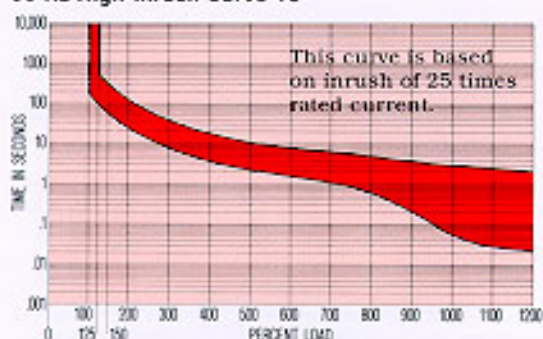

Percent of rated current vs. trip delay at 25° C

%	100%	125%	200%	400%	600%	800%	1000%
Delay Maximum (seconds)	no trip	500	110	16	7	4	2.75
Delay Minimum (seconds)	no trip	80	22	3.6	1.5	0.65	0.05

60 Hz High-inrush Curve 20

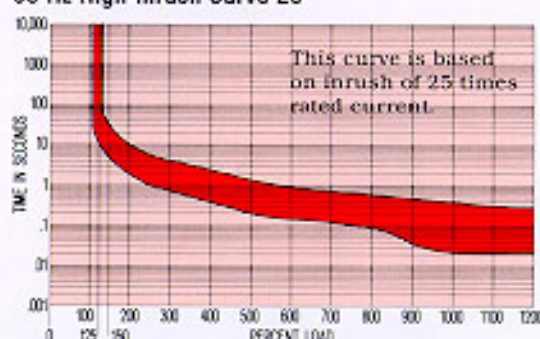

Percent of rated current vs. trip delay at 25° C

%	100%	125%	200%	400%	600%	800%	1000%
Delay Maximum (seconds)	no trip	60	8	2.0	0.80	0.50	0.35
Delay Minimum (seconds)	no trip	8	1.5	0.32	0.14	0.08	0.02

60 Hz High-inrush Curve 30

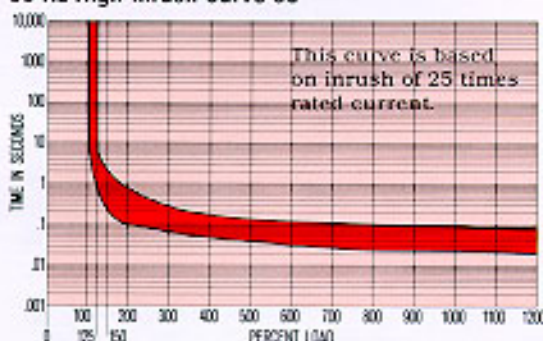

Percent of rated current vs. trip delay at 25° C

%	100%	125%	200%	400%	600%	800%	1000%
Delay Maximum (seconds)	no trip	6.4	0.74	0.16	0.13	0.11	0.097
Delay Minimum (seconds)	no trip	0.70	0.10	0.045	0.030	0.022	0.021

60 Hz High-inrush Curve 100

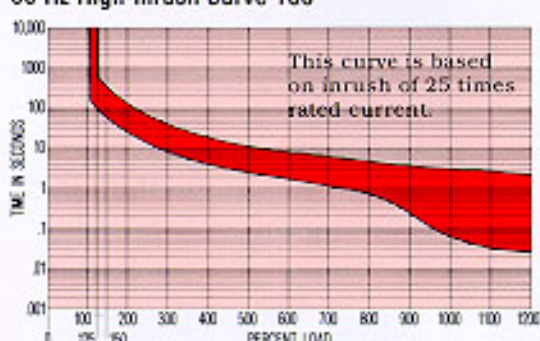

Percent of rated current vs. trip delay at 25° C

%	100%	125%	200%	400%	600%	800%	1000%
Delay Maximum (seconds)	no trip	742	200	35	17	8.5	6
Delay Minimum (seconds)	no trip	130	45	9	4	1.5	0.05

Environmental characteristics

Operating Temperature Range: -40°C to +85°C.

Fungus and moisture resistance is provided in accordance with MIL-STD-202 by treating all ferrous parts with a special moisture-resistant finish and by using special springs and fungus-resistant cases, covers and handles.

Shock tested in accordance with MIL-STD-202, Method 213, Test Condition I (100G's at 6 milliseconds).

Vibration tested in accordance with MIL-STD-202, Method 204.10-500 Hz, 0.06" total excursion on three mutually perpendicular planes. Shock and vibration tests apply to time-delay breakers only and are performed with the units carrying full rated current.

Resistance-impedance

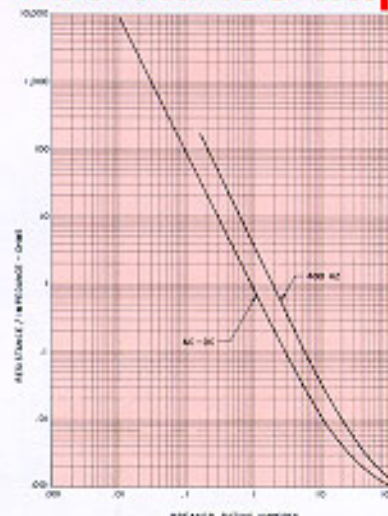

Tolerance Limits

Current (amps)	Tolerance (%)
01 to 29.9	±25
30 to 100	±35

Terminal styles

Back terminal arrangements with Series Trip and special function internal circuits

0-50 AMPS:
 #10-32 x .625±.062(15.88±1.57) LONG
 51-100 AMPS:
 1/4-20 x .750±.062(19.05±1.57) LONG

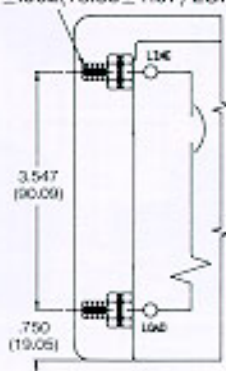

SERIES TRIP

0-50 AMPS:
 #10-32 x .687±.062(17.45±1.57) LONG
 51-100 AMPS:
 1/4-20 x .812±.062(20.82±1.57) LONG

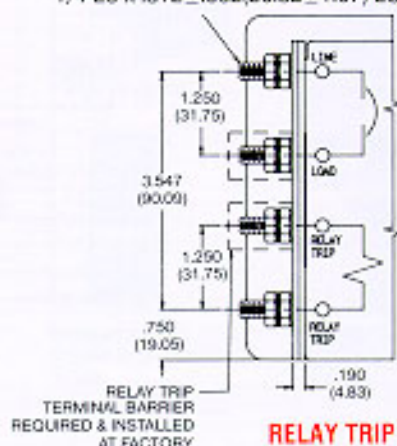

RELAY TRIP

0-50 AMPS:
 #10-32 x .625±.062(15.88±1.57) LONG
 51-100 AMPS:
 1/4-20 x .750±.062(19.05±1.57) LONG

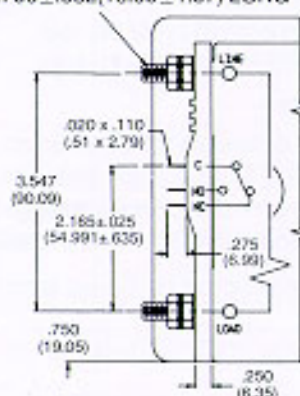

AUXILIARY SWITCH

0-50 AMPS:
 #10-32 x .687±.062(17.45±1.57) LONG
 51-100 AMPS:
 1/4-20 x .812±.062(20.62±1.57) LONG

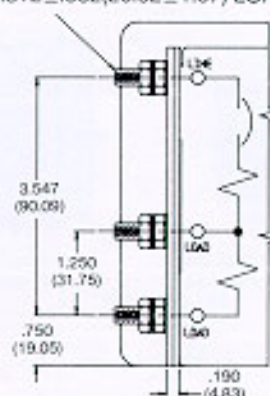

DUAL RATING

0-50 AMPS:
 #10-32 x .687±.062(17.45±1.57) LONG
 51-100 AMPS:
 1/4-20 x .812±.062(20.62±1.57) LONG

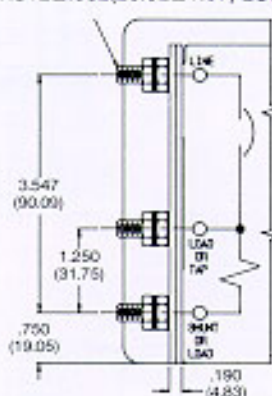

SHUNT TAP

0-50 AMPS:
 #10-32 x .687±.062(17.45±1.57) LONG
 51-100 AMPS:
 1/4-20 x .812±.062(20.62±1.57) LONG

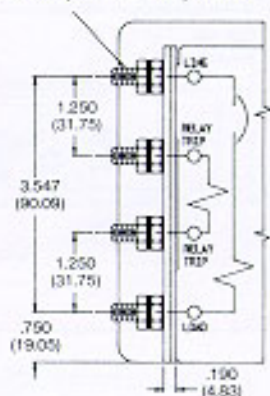

DU-CON RELAY TRIP

Flashover protection

A minimum clearance of 1.5 in. between the vent area of back-connected CD breakers and grounded obstruction is required. Anti-flashover barriers are installed between poles on the back of multipole CD breakers. Barriers extend .375 above the top of the breaker.

Front-connected load terminals

CD models 0-34 amp: 10-32 washerhead screw. CD models 34.1-100 amp and all CE and CF models: pressure connector with 3/8-24 UNF screw.

Back-connected terminals 0-50 amp: 10-32 studs. 51-100 amp: 1/4-20 studs.

Wire accepted: Pressure connector terminals will accommodate #14 through #1 copper wire.

Approximate weights: Single-pole: 9 oz; two-pole: 1 lb 3 oz; three-pole: 2 lb; four-pole: 2 lb 7 oz; five-pole: 3 lb; six-pole: 3 lb 12 oz.

Dimensions

Width dimensions are as follows:

- 1 POLE: 1.026 ± .010 (26.06 ± .25)
- 2 POLE: 2.092 (53.14) MAX
- 3 POLE: 3.138 (79.71) MAX
- 4 POLE: 4.184 (106.28) MAX
- 5 POLE: 5.230 (132.84) MAX
- 6 POLE: 6.276 (159.41) MAX

NOTE:

All dimensions are in inches/mm, tolerance ± .032/.81 except where noted. Dimensions are given here only as a preliminary guide to specifying. Final engineering drawings should be made from the latest Heinemann factory drawings, available on request.

For metric threads, consult factory.

CUTOUT & MOUNTING HOLES

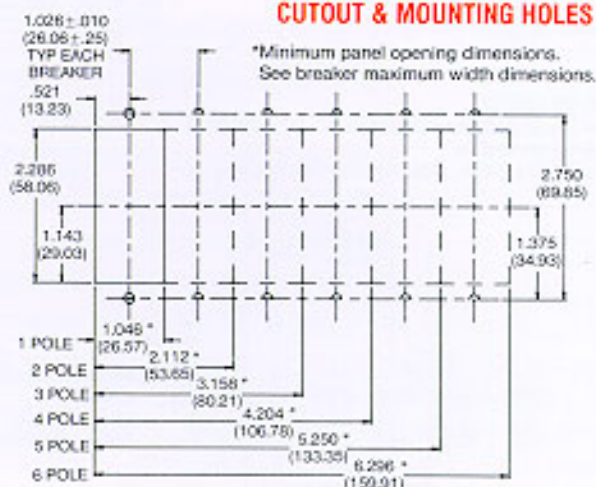

FRONT MOUNTED – BACK CONNECTED (CD)

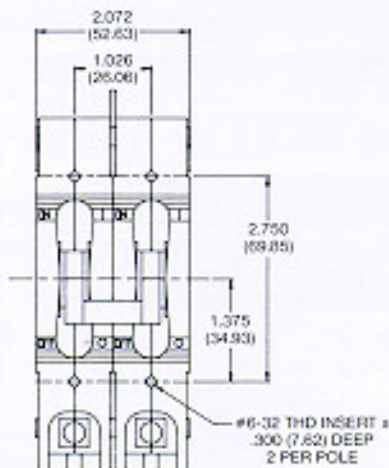
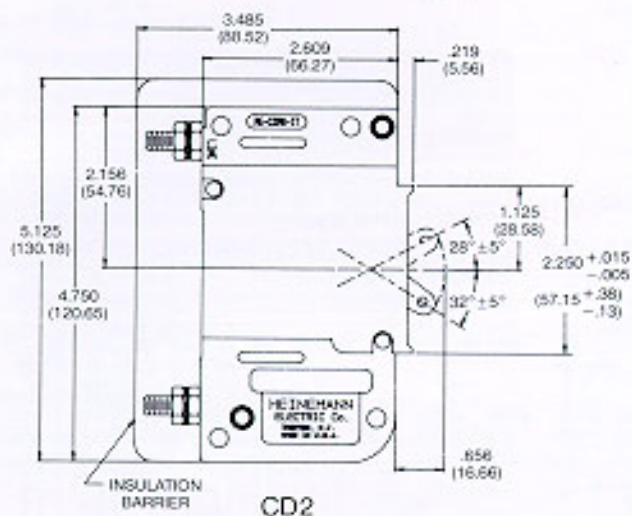

BACK MOUNTED – FRONT CONNECTED (CE & CF)

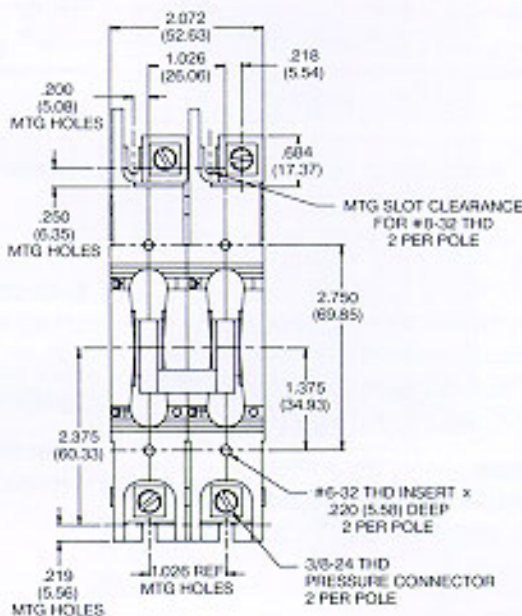
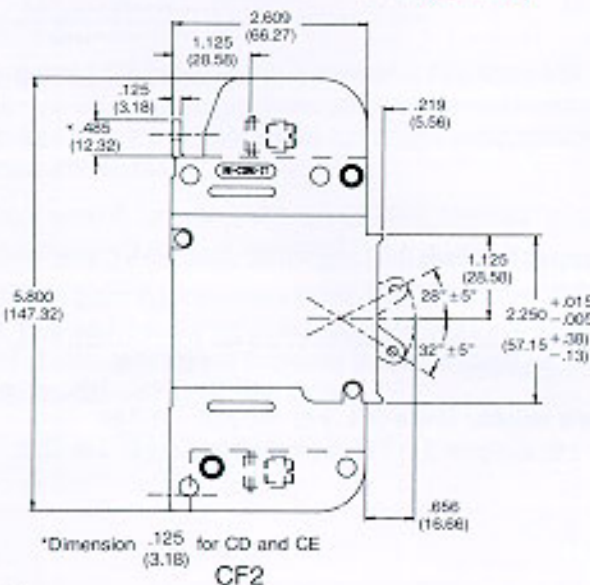

Heinemann Circuit Breakers Series CD-CE-CF

For the widest selection of circuit protection, from 0.01 to 700 amperes, look to Heinemann.

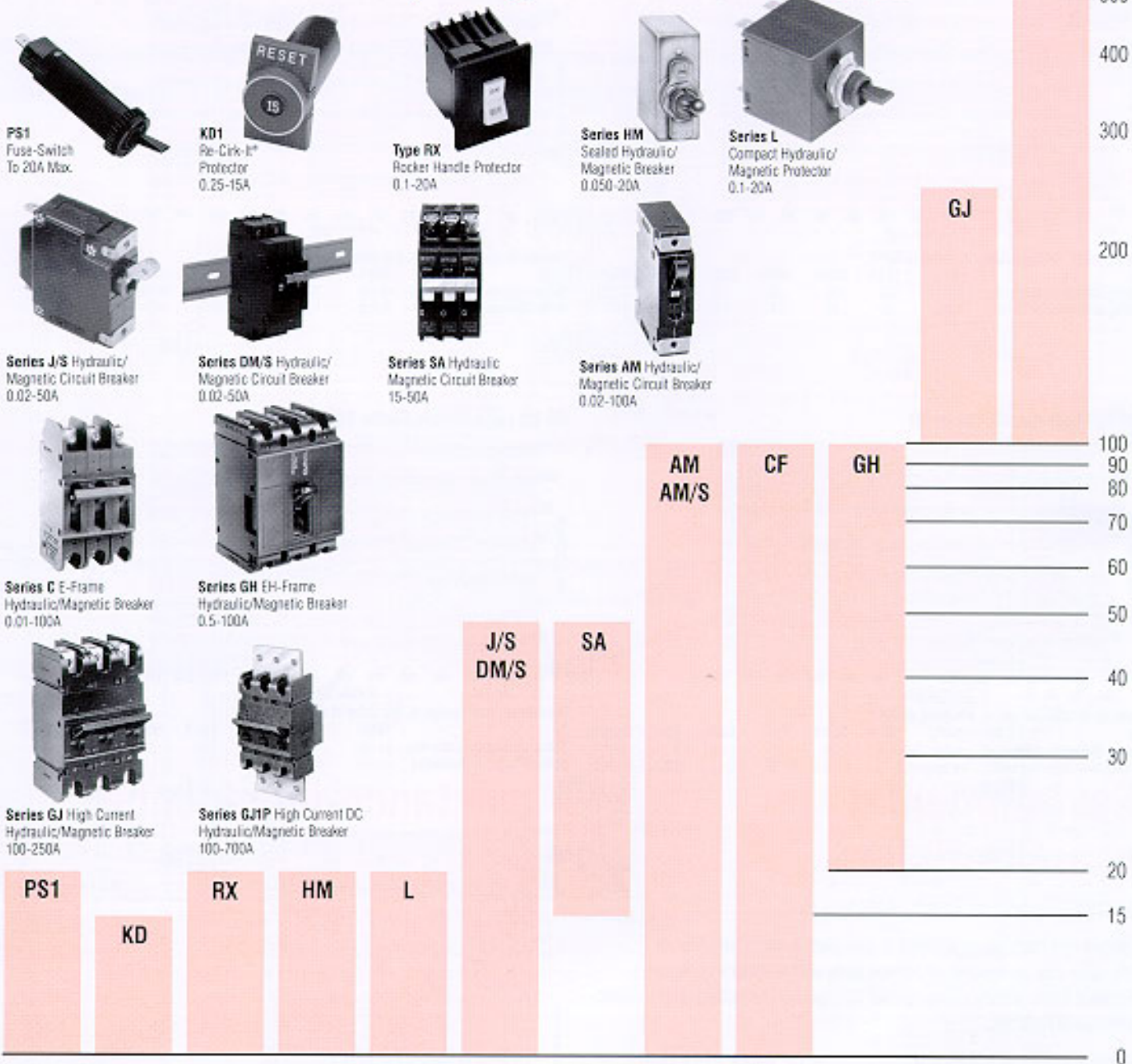

For warranty information, see CM00 Bulletin C-C7.0.

Products described by this catalog are covered by one or more United States of America patents and appropriate foreign patents, where applicable.

EATON

Printed in U.S.A.
DI-134
R972.5M93